

LCP150AD-1H24V**Summary**

LCP150AD-1H24V is a constant voltage mode output LED driver. This driver complies with DALI standard protocol IEC 62386, and provides multiple dimming function (DALI,0/1-10V active signal ,PWM, adjustable resistance,and Touch DIM) to achieve a smooth dimming effect.

Product Features

- Single channel constant voltage output,6.25A Max
- Meet DALI protocol IEC 62386
- High input voltage of 220VAC ~ 240VAC
- Dimming effect smooth, no flicker
- Over load protection; over voltage protection; short circuit protection
- IP20, suitable for indoor LED lighting application

Application

For LED constant voltage strip light only



LED Strip Light

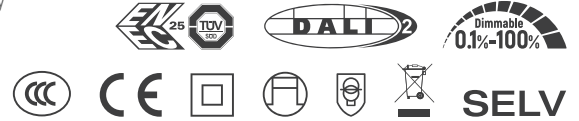

LED Tube

**Technical Parameters**

Model	LCP150AD-1H24V	
Input	Efficiency	≥92%@230VAC,Full load
	Voltage	220VAC-240VAC
	Frequency Range(Hz)	50/60Hz
	Power Factor	≥0.95@230VAC,Full load
	THD(full load)	<10%@230VAC, Full load
	AC Current(max)	0.75Amax@230VAC
	Standby power	≤1W
	No load power	≤1W
	Inrush Current(max)	Cold start,50A@230VAC 100us
Output	Current(mA)/Voltage (VDC) Power(W)	6.25A/24VDC/150W
	Channel	1
	Voltage Tolerance	±5%
	Turn on delay Time	0.75s, at230Vac (When the light begins to shine)
Function	Dimming Type	DALI/1-10V/PWM/PUSH
	Dimming Range	0.3%-100% Dimming to off
	Dimming curve	Logarithm
Protection	Over voltage	No output, self-recovery after troubleshooting
	Over load	No output, self-recovery after troubleshooting
	Short Circuit	No output, self-recovery after troubleshooting
Safety& EMC	Surge	L-N:2KV
	Withstand Voltage	I-O:3000Vac/1min/<5mA ; O-DALI&O-1-10V 1500Vac/1min/<5mA ;
	DALI Standard	IEC 62386-101: 2014, IEC 62386-102: 2014; IEC 62386-207: 2009, DALI 2.0
	Safety Standards	EN61347, GB19510
	EMC Emission	EN55015, EN61000-3-2
	EMC Immunity	EN61000-4-2, 3, 4, 5, 6, 8, 11; EN61547
Others	Working Temp.	-20°C~50°C
	Storage Temp., Humidity	-40°C~85°C, 20-90%RH
	tc	80°C @230Vac
	Material	PC
	IP Rating	IP20
	Lifetime	50,000h@tc:75°C
	Warranty Condition	5 years
	Switch Cycle	25,000 times
	Packing(weight)	Net weight: 340g±5%/PCS; 50PCS/Carton;17.5kg±5%/Carton; Carton Size: 434*302*174mm(L*W*H)
Dimension	295*40*32mm (L*W*H)	

Dimension(mm)

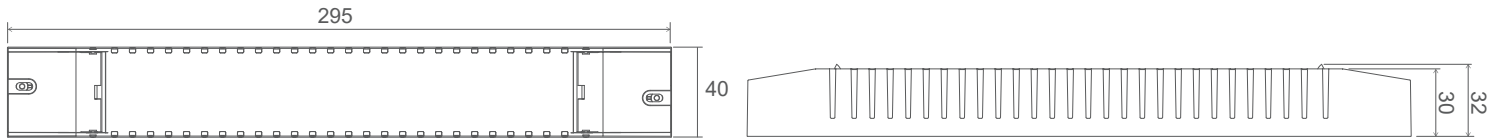

DALI Wiring

0/1-10V Wiring

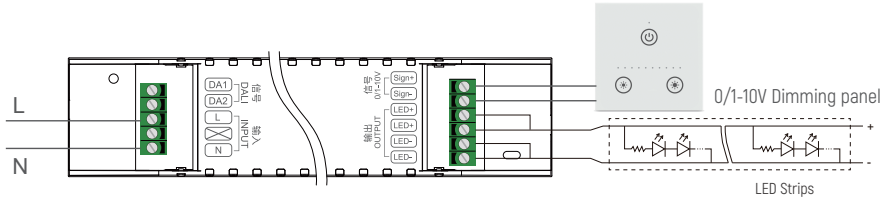

DALI Wiring

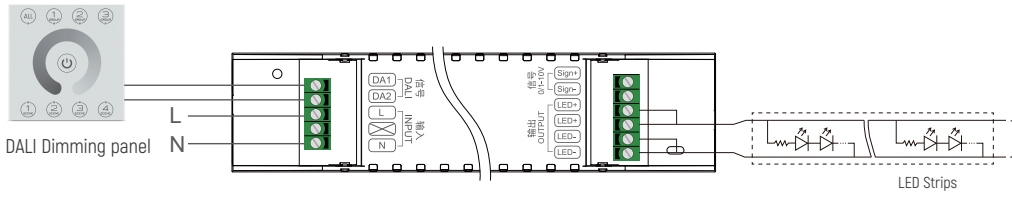

Dimming Curve

DALI Curve

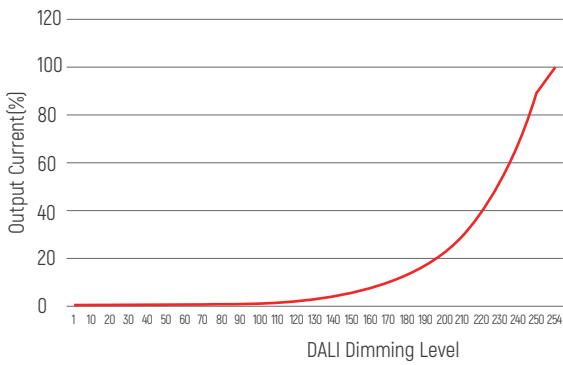

0/1-10V Curve

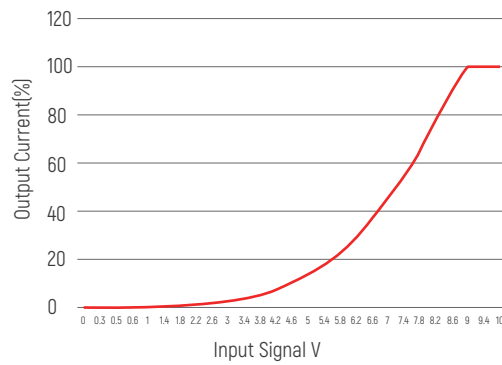

Derating Curve

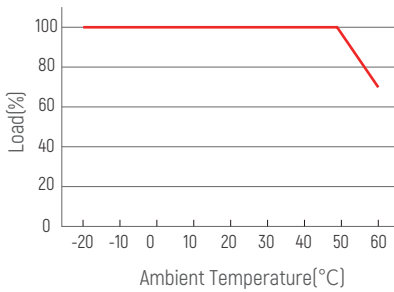

PF Curve

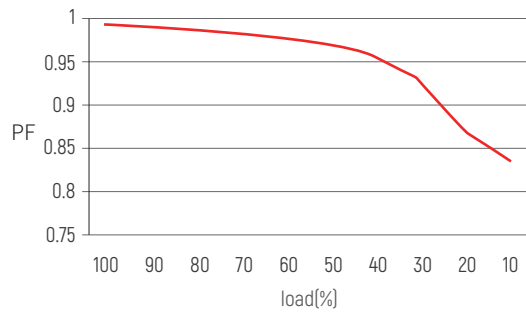

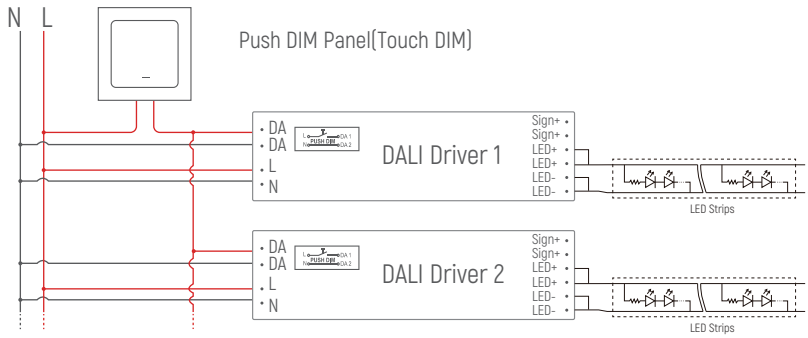
Push DIM(Touch DIM) Diagram

Remark: Only use open push button without indicator light. Maximum cable length between each Unit: 20 meters.

Push DIM Function

1. Press the Push DIM (Touch DIM) switch for 8s or more, the driver can be controlled via Push DIM switch.
2. Short press the Touch DIM switch (<0.5s) to control the lamp on or off.
3. Long press the Touch DIM switch (>0.5s) to dim the brightness of light. The dimming direction will change every time after pressing switch.
4. Double-click the Touch DIM switch (<0.3s), then all lamps connected on the device will be set maximum brightness.
5. The brightness adjustment range is 1%-100%, and the light can be turned off through short pressing when doing the adjustment with long pressing Touch DIM switch.
6. With the Power off memory function, the power-down state will be recovered when power on again.

Cautions

1. This product should be installed by qualified personnel.
2. This product is non waterproof, need to avoid sun and rain. In case of outdoor use, please ensure it is mounted in a water proof enclosure.
3. Good heat dissipation conditions extend product life. Please install the product in a well-ventilated environment.
4. Please make sure LED power supply output voltage, current is used to meet the product requirements.
5. Please ensure that adequate sized cable is used from the controller to the LED lights to carry the current. Please also ensure that the cable is secured tightly in the connector.
6. Due to safety concerns, PVC or rubber cord of 0.75- 1.5mm² is recommended for input and output terminal(s) (excluding signal terminals). Flat power cord is not suitable. Ensure all wire connections and polarities are correct before applying power to avoid any damages to the LED lights.
7. In case of malfunction, do not repair it yourself.

※ The contents of this manual are updated without prior notice. If the function of the product you are using is inconsistent with the instructions, the function of the product shall prevail. Please contact us if you have any questions.